

K00207 (2855061)
K00208 (2855071)
K00205 (2855081)
K00206 (2855051)

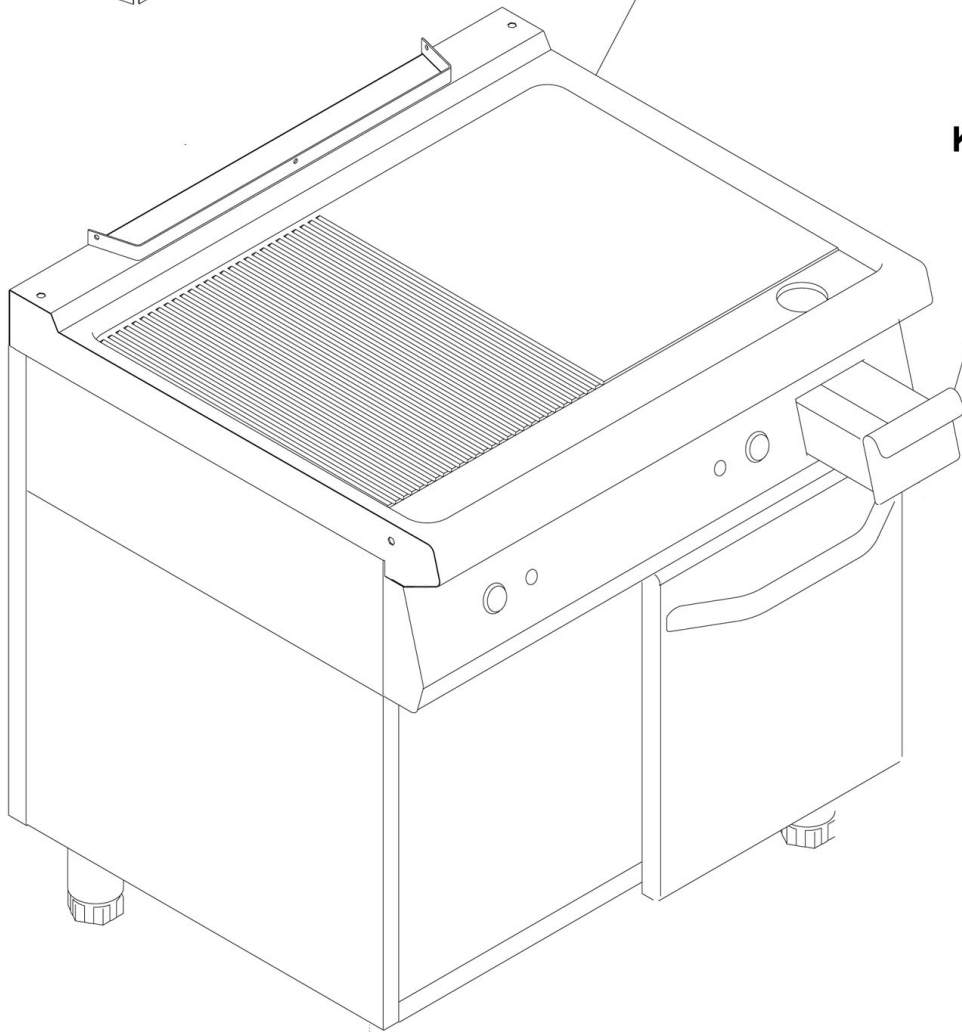

K26234

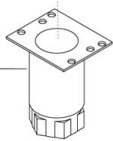

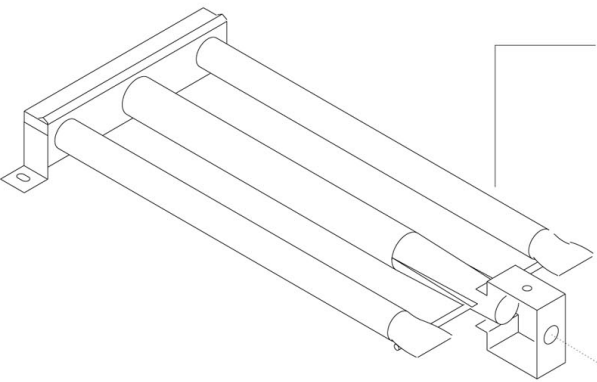

K26112

COD.	Φ	GAS
K22022	30	G30/31 28..37mbar G30/31 50mbar
K22133	51	G20 20mbar G20 25mbar G25 20mbar G25 25mbar G25.1 25mbar

COD.	Φ	GAS
K22114	130	G30/31 28..37mbar
K22108	110	G30/31 50mbar
K22103	195	G20 20mbar
K22110	180	G20 25mbar
K22105	215	G25 20mbar
K22144	200	G25 25mbar
K22116	210	G25.1 25mbar

K26113

K22189 (2855061)
(2855071)

K22016 (2855051)
(2855081)

K26021

K22000

K22023

K22196

K22019

K22002

K22003

K22005

K22004

K25815

K25814

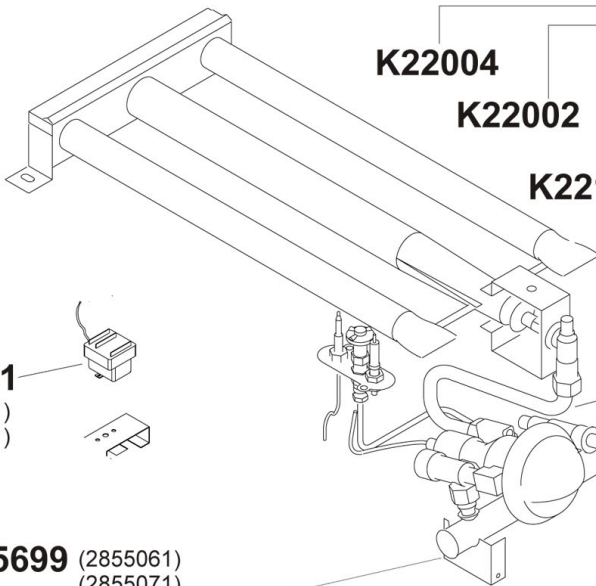

K22004

K22002

K22002

K22188

K22004

K25815

K22005

K22003

K25113

K24000

K24003

K24041
(2855061)
(2855071)

K25699 (2855061)
(2855071)

K25820 (2855051)
(2855081)

COD.	Φ	GAS
K22225	90	G30/31 28..37mbar
K22217	75	G30/31 50mbar
K22220	125	G20 20mbar G20 25mbar G25 20mbar G25 25mbar G25.1 25mbar

Pos.	Artikelbeschreibung	Description of item	Artikel Nr./Item No.
K00188	Fettauffangschublade	Grease drip drawer	049999
K00205	Griddleplatte, glatt	Griddle plate, smooth	E051029
K00206	Griddleplatte, 1/2 glatt-1/2 gerillt	Griddle plate 1/2smooth-1/2grooved	E051030
K00207	Griddleplatte, glatt	Griddle plate, smooth	E051031
K00208	Griddleplatte, gerillt	Griddle plate, grooved	E051032
K22000 K26021	Düsenträger, D 10 mm, m. Mutter	Nozzle holder, D 10 mm, w. nut	049090
K22002	Doppelkegelring D 10 mm	Double taper seal D 10 mm	049818
K22003	Schneidring	Cutting ring	0MA673600
K22004	Mutter f. Doppelkegelring	Nut f. double taper seal	049819
K22005	Muffennippel, Messing	Bush nipple, brass	024540
K22016	Thermoelement 450 mm	Thermocouple 450 mm	049608
K22019	Zündbrenner, 3-Flammig	Ignition burner, 3 burners	049251
K22022	Zünddüse, Propan, D 30, 37/50 mbar	Ignition nozzle, propane, D30,50mbar	049395
K22023	Zündkerze	Ignition plug	01888300
K22103	Düse, D 195, G 20, 20 mbar	Nozzle, D 195, G 20, 20 mbar	049604
K22105	Düse, D 215, G 25, 20 mbar	Nozzle, D 215, G 25, 20 mbar	049605
K22108	Düse, Propan, D 110	Nozzle, propane, D 110	049603
K22114	Düse, Propan, D 130, 37 mbar	Nozzle, propane, D 130	049329
K22116	Düse, Erdgas H, D 210	Nozzle, natural gas H, D 210	049615
K22133	Zünddüse, Erdgas, D 51, G 20	Ignition nozzle, nat.gas, D 51, G 20	049396
K22188	Armatur	Armature	049187
K22189	Thermoelement m. Kabel	Thermocouple w. cable	049232
K22196	Dichtung	Sealing	051009
K22217	Kleinstellschraube, Propan, D 75	Min.regulating screw,propane, D75	049153
K22220	Kleinstellschraube, Erdgas, D 125	Min. regulating screw,nat.gas, D125	049609
K24000	Zündkabel 450 mm	Ignition cable 450 mm	049311
K24003	Piezozünder D 18 mm	Piezo igniter D 18 mm	049069
K24041	Sicherheitsthermostat L.120	Safety thermostat L.120	049389
K25113	Knebel	Knob	049066
K25699	Gasrampe	Gas ramp	049934
K25700	Gasrampe	Gas ramp	049188
K25814	Zündgasleitung	Pilot gas pipe	051000
K25815	Hauptgasleitung	Main gas pipe	051011
K26021	Mutter M 14 x 1	Nut M 14 x 1	049339
K26112 K26113	Brenner m. Einstellungsbuchse	Burner w. air regulation bush	049600
K26234	Fuß komplett, H120/170	Complete base, H120/170	049034
	Fuß komplett, H150/200	Complete base, H150/200	049014
	Fuß H130/190, mit Gewinde	Foot H130/190, w. thread	E026437
o. Abb./ no pic.	Spritzschutz 700, 40cm breit	Splash guard 700, 40cm wide	285070
	Spritzschutz 700, 80cm breit	Splash guard 700, 80cm wide	285075
für 2855051 2855061	Düsensatz, Propan G30, 30mbar	Nozzle set, propane G30, 30mbar	E073045
für 2855071	Düsensatz, Propan G30, 30mbar	Nozzle set, propane G30, 30mbar	E073046
für 2855081	Düsensatz, Propan G30, 30mbar	Nozzle set, propane G30, 30mbar	E073033