

blu'box

cool-accu

Original - Bedienungsanleitung Art. Nr. 4000388

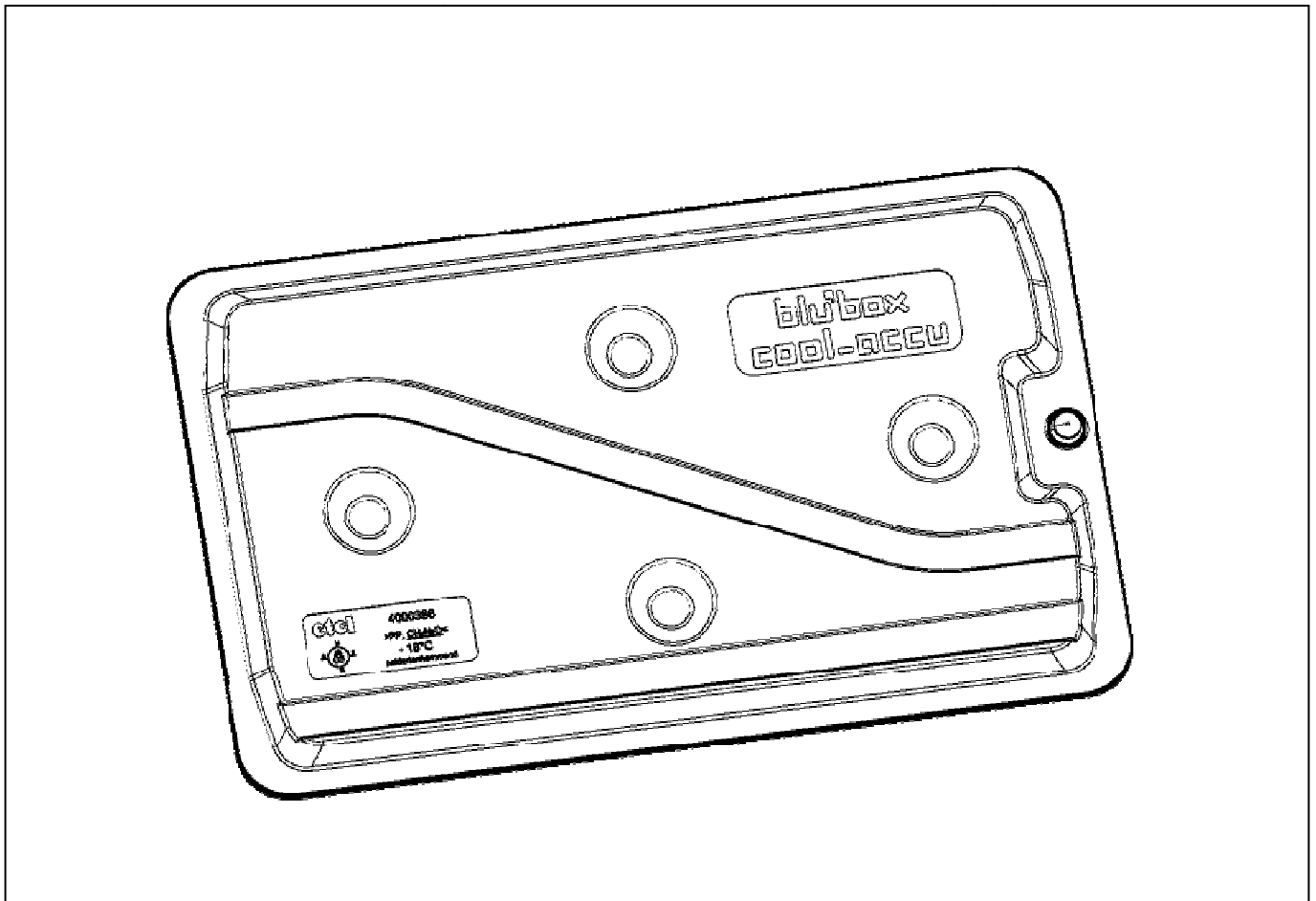

Transportieren von kalten Speisen und Getränken in Verbindung mit
blu'box 13, blu'box 26 oder blu'box 52

- **Verwendung**

- im hohen Deckel Art. Nr. 664201677

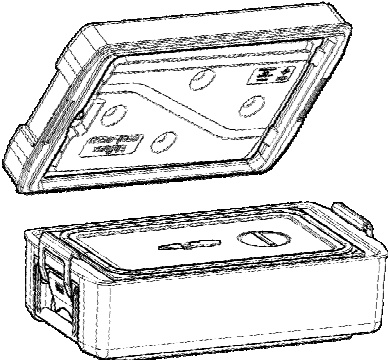
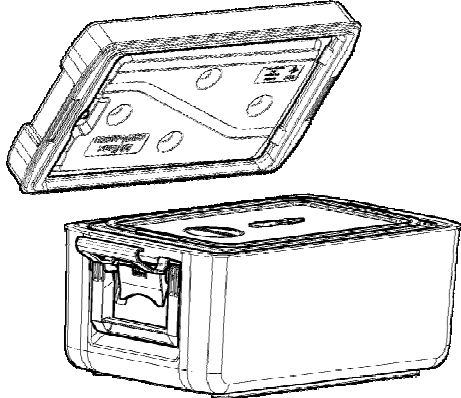
blu'box 13	Artikel - Nr.	blu'box 26	Artikel - Nr.
blu'box 13 eco	4000528	blu'box 26 eco	4000349
blu'box 13 standard	4000529	blu'box 26 eco plus	4000442
		blu'box 26 eco plus liquid	4000409
		blu'box 26 standard	4000330
		blu'box 26 plus	4000410
		blu'box 26 plus liquid	4000392
			

- als Einschub in den blu'box 52

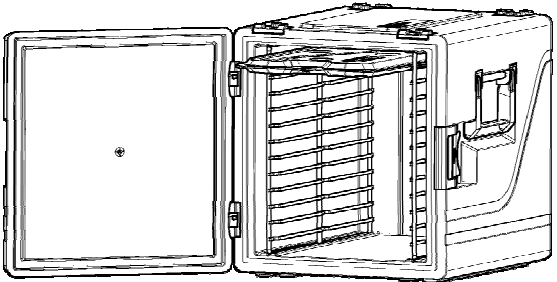
blu'box 52	Artikel - Nr.	
blu'box 52 gn	4000445	
blu'box 52 gn / en	4000348	

- Temperaturbereich

- 18°C ≤ t ≤ + 70°C

- **Gebrauchsanleitung**

- Entnahme des cool - accu Art. Nr. 4000388

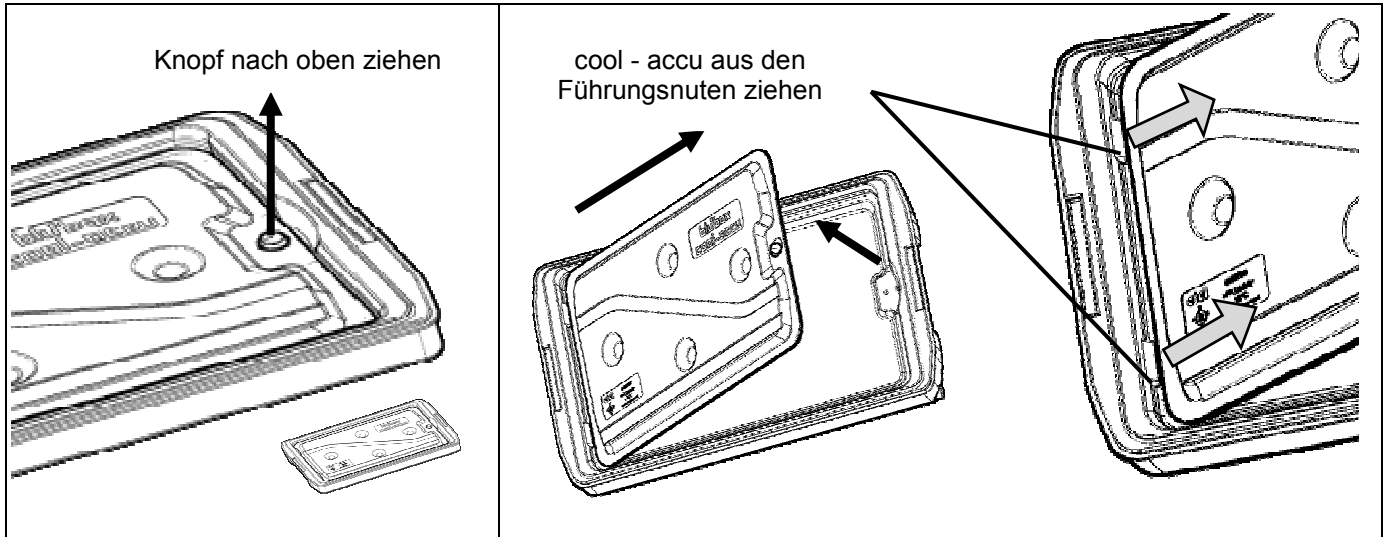

- Bestückung mit dem cool - accu

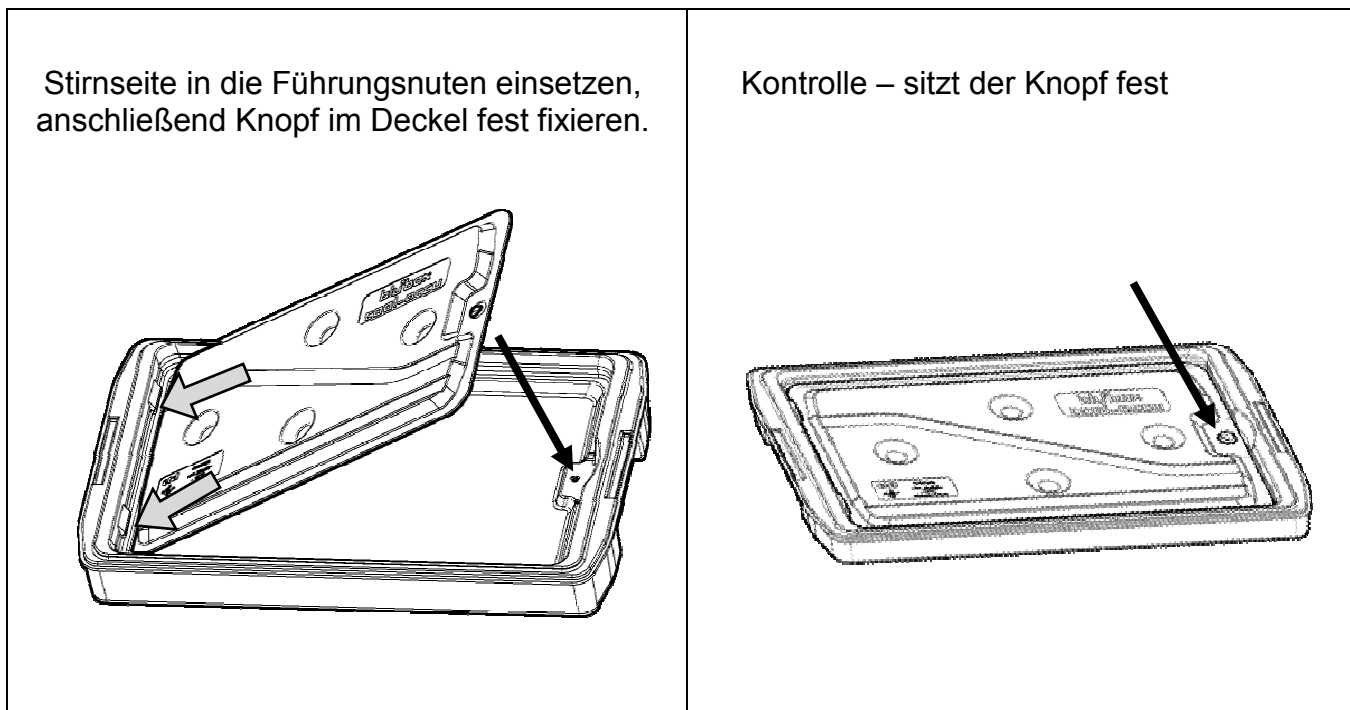

• Reinigung

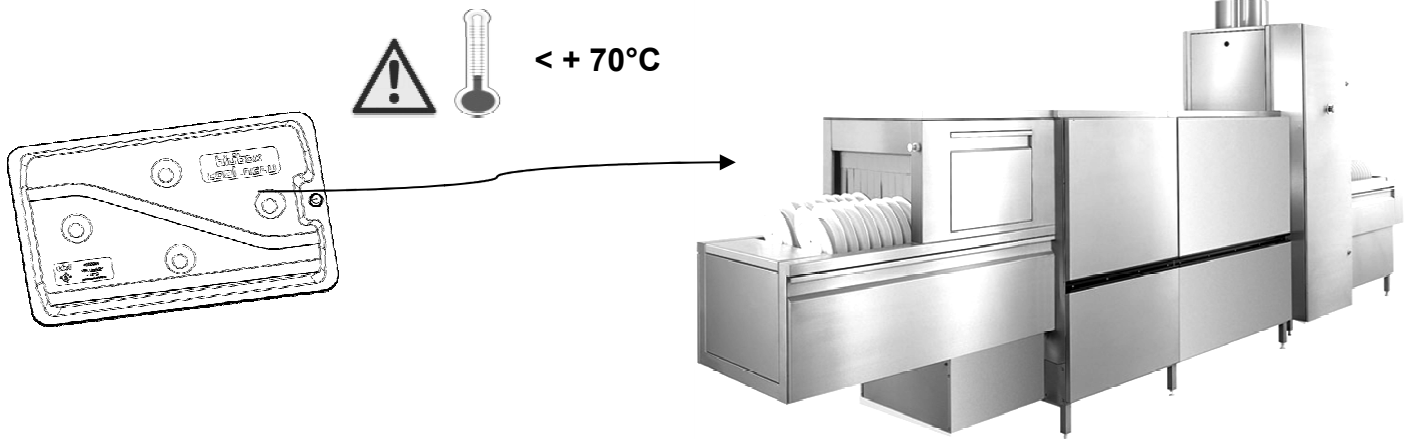

- Die cool – accu s sind spülmaschinentauglich.
- Für die Reinigung empfehlen wir etolit 3000 oder 8000.
- Bitte reinigen Sie **NICHT** mit einem Hochdruckreiniger.

• Lagerung

Die cool - accus müssen korrekt liegend aufeinander gestapelt und in sauberen, trockenen Räumen gelagert werden.

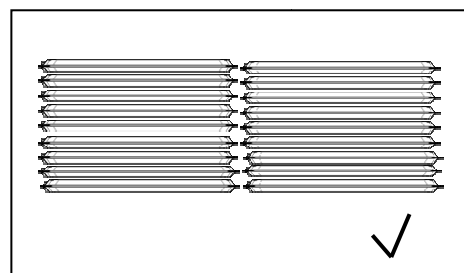
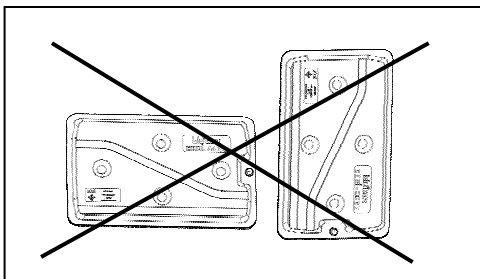

• Handling

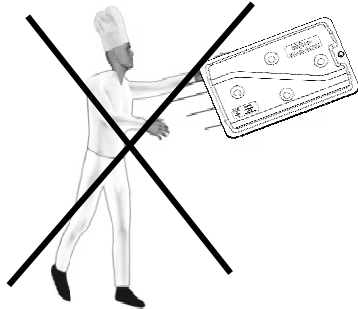
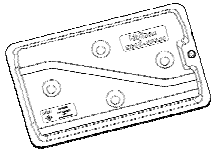
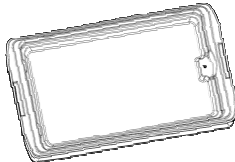
 <p>Bitte die Teile NICHT werfen</p>		<p>cool-accu Art.Nr. 4000388</p>  <p>hoher Deckel Art.Nr. 664201677</p> 
--	---	--

• Technische Daten

Hauptabmessungen und Gewichte

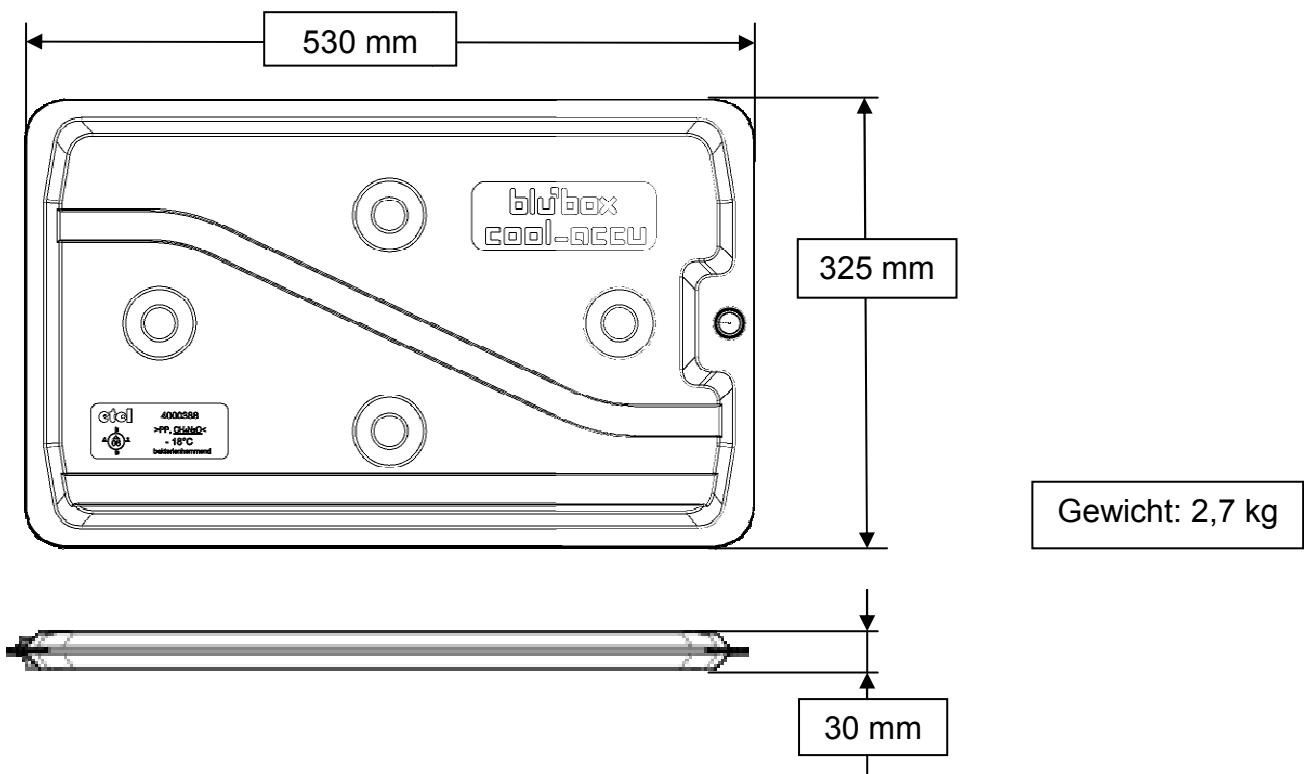

- **Hersteller**



etol Eberhard Tripp GmbH • Allerheiligenstraße 12 • 77728 Oppenau • Germany
T. +49 (0) 7804 410 www.bluline.de - info.bluline@etol.de

- **Notizen**

Starke Produkte für die Großküche.
www.etol.de



etol Eberhard Tripp GmbH • Allerheiligenstraße 12 • 77728 Oppenau • Germany
T. +49 (0)7804 410 • www.bluline.de • info.bluline@etol.de